



# Shadow Grey DDR4 UDIMM Memory Module Specifications



## Revision History

Revision No.	History	Draft Date	Remark
1.0	Initial Release	May.2022	

## Ordering Information Table

Model	Type	Capacity	Speed	Latency	Voltage
NTSDD4P36DP-16E	DDR4 UDIMM	16GB (8GB x 2)	3600MHz	18-22-22-42	1.35V
NTSDD4P32DP-32E	DDR4 UDIMM	32GB (16GB x 2)	3200MHz	16-20-20-40	1.35V
NTSDD4P32DP-16E	DDR4 UDIMM	16GB (8GB x 2)	3200MHz	16-20-20-40	1.35V
NTSDD4P30DP-32E	DDR4 UDIMM	32GB (16GB x 2)	3000MHz	16-20-20-40	1.35V
NTSDD4P30DP-16E	DDR4 UDIMM	16GB (8GB x 2)	3000MHz	16-20-20-40	1.35V
NTSDD4P26DP-32E	DDR4 UDIMM	32GB (16GB x 2)	2666MHz	19-19-19-43	1.2V
NTSDD4P26DP-16E	DDR4 UDIMM	16GB (8GB x 2)	2666MHz	19-19-19-43	1.2V
NTSDD4P36SP-16E	DDR4 UDIMM	16GB	3600MHz	18-22-22-42	1.35V
NTSDD4P36SP-08E	DDR4 UDIMM	8GB	3600MHz	18-22-22-42	1.35V
NTSDD4P32SP-16E	DDR4 UDIMM	16GB	3200MHz	16-20-20-40	1.35V
NTSDD4P32SP-08E	DDR4 UDIMM	8GB	3200MHz	16-20-20-40	1.35V
NTSDD4P30SP-16E	DDR4 UDIMM	16GB	3000MHz	16-20-20-40	1.35V
NTSDD4P30SP-08E	DDR4 UDIMM	8GB	3000MHz	16-20-20-40	1.35V
NTSDD4P26SP-16E	DDR4 UDIMM	16GB	2666MHz	19-19-19-43	1.2V
NTSDD4P26SP-08E	DDR4 UDIMM	8GB	2666MHz	19-19-19-43	1.2V

## Description

Netac Unbuffered DDR4 SDRAM DIMMs (Unbuffered Double Data Rate Synchronous DRAM Dual In-Line Memory Modules) are low power, high-speed operation memory modules that use DDR4 SDRAM devices. Each 288-pin DIMM uses gold contact fingers. The SDRAM Unbuffered DIMM is intended for use as main memory when installed in systems such as PCs.

## Features

- Specially designed aluminum alloy heat Spreader
- On-board I<sup>2</sup> serial presence-detect (SPD) EEPROM
- Fixed burst chop (BC) of 4 and burst length (BL) of 8 via the mode register set (MRS)
- Databus write cyclic redundancy check (CRC)
- Temperature controlled refresh (TCR)
- Command/Address (CA) parity
- Per DRAM Addressability is supported
- 8 bit pre-fetch
- Fly-by topology
- Command/Address latency (CAL)
- Terminated control command and address bus
- PCB: Height 1.23" (31.25mm)
- Gold edge contacts
- RoHS Compliant and Halogen-Free

## Pin Assignments

Pin	Front Side	Pin	Back Side	Pin	Front Side	Pin	Back Side
1	NC	145	NC	74	CK0_t	218	CK1_t
2	VSS	146	VREFCA	75	CK0_c	219	CK1_c
3	DQ4	147	VSS	76	VDD	220	VDD
4	VSS	148	DQ5	77	VTT	221	VTT
5	DQ0	149	VSS	KEY			
6	VSS	150	DQ1				
7	DM0_n, DBI0_n, NC	151	VSS	78	EVENT_n	222	PARITY
8	NC	152	DQS0_c	79	A0	223	VDD
9	VSS	153	DQS0_t	80	VDD	224	BA1
10	DQ6	154	VSS	81	BA0	225	A10/AP
11	VSS	155	DQ7	82	RAS_n/A16	226	VDD
12	DQ2	156	VSS	83	VDD	227	RFU
13	VSS	157	DQ3	84	CS0_n	228	WE_n/A14
14	DQ12	158	VSS	85	VDD	229	VDD
15	VSS	159	DQ13	86	CAS_n/A15	230	NC
16	DQ8	160	VSS	87	ODT0	231	VDD
17	VSS	161	DQ9	88	VDD	232	A13
18	DM1_n, DBI1_n, NC	162	VSS	89	CS1_n	233	VDD
19	NC	163	DQS1_c	90	VDD	234	NC
20	VSS	164	DQS1_t	91	ODT1	235	NC
21	DQ14	165	VSS	92	VDD	236	VDD
22	VSS	166	DQ15	93	NC	237	NC
23	DQ10	167	VSS	94	VSS	238	SA2
24	VSS	168	DQ11	95	DQ36	239	VSS
25	DQ20	169	VSS	96	VSS	240	DQ37
26	VSS	170	DQ21	97	DQ32	241	VSS
27	DQ16	171	VSS	98	VSS	242	DQ33
28	VSS	172	DQ17	99	DM4_n, DBI4_n, NC	243	VSS
29	DM2_n, DBI2_n, NC	173	VSS	100	NC	244	DQS4_c
30	NC	174	DQS2_c	101	VSS	245	DQS4_t
31	VSS	175	DQS2_t	102	DQ38	246	VSS
32	DQ22	176	VSS	103	VSS	247	DQ39
33	VSS	177	DQ23	104	DQ34	248	VSS
34	DQ18	178	VSS	105	VSS	249	DQ35
35	VSS	179	DQ19	106	DQ44	250	VSS
36	DQ28	180	VSS	107	VSS	251	DQ45

37	VSS	181	DQ29	108	DQ40	252	VSS
38	DQ24	182	VSS	109	VSS	253	DQ41
39	VSS	183	DQ25	110	DM5_n, DBI5_n, NC	254	VSS
40	DM3_n, DBI3_n, NC	184	VSS	111	NC	255	DQS5_C
41	NC	185	DQS3_c	112	VSS	256	DQS5_t
42	VSS	186	DQS3_t	113	DQ46	257	VSS
43	DQ30	187	VSS	114	VSS	258	DQ47
44	VSS	188	DQ31	115	DQ42	259	VSS
45	DQ26	189	VSS	116	VSS	260	DQ43
46	VSS	190	DQ27	117	DQ52	261	VSS
47	CB4, NC	191	VSS	118	VSS	262	DQ53
48	VSS	192	CB5, NC	119	DQ48	263	VSS
49	CB0, NC	193	VSS	120	VSS	264	DQ49
50	VSS	194	CB1, NC	121	DM6_n, DBI6_n, NC	265	VSS
51	DM8_n, DBI8_n, NC	195	VSS	122	NC	266	DQS6_c
52	NC	196	DQS8_c	123	VSS	267	DQS6_t
53	VSS	197	DQS8_t	124	DQ54	268	VSS
54	CB6, NC	198	VSS	125	VSS	269	DQ55
55	VSS	199	CB7, NC	126	DQ50	270	VSS
56	CB2, NC	200	VSS	127	VSS	271	DQ51
57	VSS	201	CB3, NC	128	DQ60	272	VSS
58	RESET_n	202	VSS	129	VSS	273	DQ61
59	VDD	203	CKE1	130	DQ56	274	VSS
60	CKE0	204	VDD	131	VSS	275	DQ57
61	VDD	205	RFU	132	DM7_n, DBI7_n, NC	276	VSS
62	ACT_n	206	VDD	133	NC	277	DQS7_c
63	BG0	207	BG1	134	VSS	278	DQS7_t
64	VDD	208	ALERT_n	135	DQ62	279	VSS
65	A12/BC_n	209	VDD	136	VSS	280	DQ63
66	A9	210	A11	137	DQ58	281	VSS
67	VDD	211	A7	138	VSS	282	DQ59
68	A8	213	VDD	139	SA0	283	VSS
69	A6	214	A5	140	SA1	284	VDDSPD
70	VDD	215	A4	141	SCL	285	SDA
71	A3	215	VDD	142	VPP	286	VPP
72	A1	216	A2	143	VPP	287	VPP
73	VDD	217	VDD	144	RFU	288	VPP

**Note:** The pin assignment table above is a comprehensive list of all possible pin assignments for DDR4 UDIMM modules. See Functional Block Diagram for pins specific to this module.

## Pin Descriptions

Pin Name	Description	Pin Name	Description
A0-A17 <sup>1</sup>	SDRAM address bus	SCL	I2C serial bus clock for SPD-TSE
BA0, BA1	SDRAM bank select	SDA	I2C serial bus line for SPD-TSE
BG0, BG1	SDRAM bank group select	SA0-SA2	I2C slave address select for SPD-TSE
RAS <sub>n</sub> <sup>2</sup>	SDRAM row address strobe	PARITY	SDRAM parity input
CAS <sub>n</sub> <sup>3</sup>	SDRAM column address strobe	VDD	SDRAM I/O and core power supply
WE <sub>n</sub> <sup>4</sup>	SDRAM write enable	C0, C1, C2	Chip ID lines
CS0 <sub>n</sub> , CS1 <sub>n</sub> ,	DIMM Rank Select Lines	12V	Optional power Supply on socket but not used on UDIMM
CKE0, CEK1	SDRAM clock enable lines input	VREFCA	SDRAM command/address reference supply
ODT0, ODT1	SDRAM on-die termination control lines input	VSS	Power supply return (ground)
ACT <sub>n</sub>	SDRAM activate	VDDSPD	Serial SPD-TSE positive power supply
DQ0-DQ63	DIMM memory data bus	ALERT <sub>n</sub>	SDRAM ALERT <sub>n</sub> output
CB0-CB7	DIMM ECC check bits	VPP	SDRAM Supply
TDQS0 <sub>t</sub> -TDQS8 <sub>t</sub> TDQS0 <sub>c</sub> -TDQS8 <sub>c</sub>	Dummy loads for mixed populations of x4 based and x8 based RDIMMs. Not used on UDIMMs.		
DQS0 <sub>t</sub> -DQS8 <sub>t</sub>	SDRAM data strobes(positive line of differential pair)		
DQS0 <sub>c</sub> -DQS8 <sub>c</sub>	SDRAM data strobes(negative line of differential pair)	RESET <sub>n</sub>	Set DRAMs to a Known State
DM0 <sub>n</sub> -DM8 <sub>n</sub> , DBI0 <sub>n</sub> -DBI8 <sub>n</sub>	SDRAM data masks/data bus inersion(x8-based x72 DIMMs)	EVENT <sub>n</sub>	SPD signals a thermal event has occurred
CK0 <sub>t</sub> , CK1 <sub>t</sub>	SDRAM clock (positive line of differential pair)	VTT	SDRAM I/O termination supply
CK0 <sub>c</sub> , CK1 <sub>c</sub>	SDRAM clock (positive line of differential pair)	RFU	Reserved for future use

### Notes:

1. Address A17 is not valid for x8 and x16 based SDRAMs. For UDIMMs, this connection pin is NC.
2. RAS<sub>n</sub> is a multiplexed function with A16.
3. CAS<sub>n</sub> is a multiplexed function with A15.
4. WE<sub>n</sub> is a multiplexed function with A14.

## Input/Output Functional Descriptions

Symbol	Type	Function
CK0_t, CK0_c, CK1_t, CK1_c	Input	Clock: CK_t and CK_c are differential clock are sampled on the crossing of the positive inputs. All address and control input signals edge of CK_t and negative edge of CK_c.
CKE0, CKE1	Input	Clock Enable: CKE HIGH activates and CKE LOW deactivates internal clock signals and device input buffers and output drivers. Taking CKE LOW provides Precharge Power Down and Self-Refresh operation (all banks idle), or Active Power-Down (row Active in any bank). CKE is asynchronous for Self-Refresh exit. After VREFCA and Internal DQ Vref have become stable during the power on and initialization sequence, they must be maintained during all operations (including Self-Refresh). CKE must be maintained high throughout read and write accesses. Input buffers, excluding CK_t, CK_c, ODT and CKE, are disabled during power-down. Input buffers, excluding CKE, are disabled during Self-Refresh.
CS0_n, CS1_n, CS2_n, CS3_n	Input	Chip Select: All commands are masked when CS_n is registered HIGH. CS_n provides for external Rank selection on systems with multiple Ranks. CS_n is considered part of the command code. CS2_n and CS_3_n are not used on UDIMMs.
C0, C1, C2	Input	Chip ID: Chip ID is only used for 3DS for 2,4,8 high stack via TSV to select each slice of stacked component. Chip ID is considered part of the command code. Not used on UDIMMs.
ODT0, ODT1	Input	On-Die Termination: ODT (registered HIGH) enables RTT_NOM termination resistance internal to the DDR4 SDRAM. When enabled, ODT is only applied to each DQ, DQS_t, DQS_c and DM_n/DBI_n/TDQS_t, NU/TDQS_c (When TDQS is enabled via Mode Register A11=1 in MR1) signal for x8 configurations. For x16 configuration, ODT is applied to each DQ, DQSU_t, DQSU_c, DQSL_t, DQSL_c, DMU_n, and DML_n signal. The ODT pin will be ignored if MR1 is programmed to disable RTT_NOM.
ACT_n	Input	Activation Command Input: ACT_n defines the Activation command being entered along with CS_n. The input into RAS_n/A16, CAS_n/A15 and WE_n/A14 will be considered as Row Address A16, A15 and A14.
RAS_n/A16, CAS_n/A15, WE_n/A14	Input	Command Inputs: RAS_n/A16, CAS_n/A15 and WE_n/A14 (along with CS_n) define the command being entered. Those pins have multi function. For example, for activation with ACT_n Low, these are Addresses like A16, A15, and A14. But for non-activation command with ACT_n High, these are Command pins for Read, Write, and other commands defined in command truth table.
DM_n/DBI_n/TDQS _t, (DMU_n/DBIU_n), (DML_n/DBIL_n)	Input/ Output	Input Data Mask and Data Bus Inversion: DM_n is an input mask signal for write data. Input data is masked when DM_n is sampled LOW coincident with that input data during a Write access. DM_n is sampled on both edges of DQS. DM is muxed with DBI function by Mode Register A10, A11, A12 setting in MR5. For x8 device, the function of DM or TDQS is enabled by Mode Register A11 setting in MR1. DBI_n is an input/output identifying whether to store/output the true or inverted data. If DBI_n is LOW, the data will be stored/output after inversion inside the DDR4 SDRAM and not



		inverted if DBI_n is HIGH. TDQS is only supported in x8 SDRAM configurations. TDQS is not valid for UDIMMs.
BG0, BG1	Input	Bank Group Inputs: BG0 - BG1 define which bank group an Active, Read, Write, or Precharge command is being applied. BG0 also determines which mode register is to be accessed during a MRS cycle. x4/x8 SDRAM configurations have BG0 and BG1. x16 based SDRAMs only have BG0.
BA0, BA1	Input	Bank Address Inputs: BA0 - BA1 define to which bank an Active, Read, Write or Precharge command is being applied. Bank address also determines which mode register is to be accessed during a MRS cycle.
A0 - A17	Input	Address Inputs: Provide the row address for ACTIVATE Commands and the column address for Read/Write commands to select one location out of the memory array in the respective bank. A10/AP, A12/BC_n, RAS_n/A16, CAS_n/A15 and WE_n/A14 have additional functions. See other rows. The address inputs also provide the op-code during Mode Register Set commands. A17 is only defined for the x4 SDRAM configuration.
A10 / AP	Input	Auto-precharge: A10 is sampled during Read/Write commands to determine whether Autoprecharge should be performed to the accessed bank after the Read/Write operation. (HIGH: Autoprecharge; LOW: no Autoprecharge). A10 is sampled during a Precharge command to determine whether the Precharge applies to one bank (A10 LOW) or all banks (A10 HIGH). If only one bank is to be precharged, the bank is selected by bank addresses.
A12 / BC_n	Input	Burst Chop: A12/BC_n is sampled during Read and Write commands to determine if burst chop (on-the-fly) will be performed. (HIGH, no burst chop; LOW: burst chopped). See command truth table for details.
RESET_n	CMOS Input	Active Low Asynchronous Reset: Reset is active when RESET_n is LOW, and inactive when RESET_n is HIGH. RESET_n must be HIGH during normal operation.
DQ	Input/ Output	Data Input/ Output: Bi-directional data bus. If CRC is enabled via Mode register then CRC code is added at the end of Data Burst. Any DQ from DQ0-DQ3 may indicate the internal Vref level during test via Mode Register Setting MR4 A4=High. Refer to vendor specific data sheets to determine which DQ is used.
DQS_t, DQS_c, DQSU_t, DQSU_c, DQSL_t, DQSL_c	Input/ Output	Data Strobe: output with read data, input with write data. Edge-aligned with read data, centered in write data. For the x16, DQSL corresponds to the data on DQL0-DQL7; DQSU corresponds to the data on DQU0-DQU7. The data strobe DQS_t, DQSL_t and DQSU_t are paired with differential signals DQS_c, DQSL_c, and DQSU_c, respectively, to provide differential pair signaling to the system during reads and writes. DDR4 SDRAM supports differential data strobe only and does not support single-ended.
TDQS_t, TDQS_c	Output	Termination Data Strobe: TDQS_t/TDQS_c are not valid for UDIMMs.
PARITY	Input	Command and Address Parity Input : DDR4 Supports Even Parity check in DRAMs with MR setting. Once it's enabled via Register in MR5, then DRAM calculates Parity with ACT_n, RAS_n/A16, CAS_n/A15, WE_n/A14, BG0-BG1, BA0-BA1, A16-A0. Input parity should be maintained at the rising edge of the clock and at the same time with command & address with CS_n LOW.

## Absolute Maximum Ratings

### Absolute Maximum DC Ratings

Symbol	Parameter	Rating	Units	NOTE
VDD	Voltage on VDD pin relative to Vss	-0.3 ~ 1.5	V	1,3
VDDQ	Voltage on VDDQ pin relative to Vss	-0.3 ~ 1.5	V	1,3
VPP	Voltage on VPP pin relative to Vss	-0.3 ~ 3.0	V	4
VIN, VOUT	Voltage on any pin except VREFCA relative to Vss	-0.3 ~ 1.5	V	1,3,5
TSTG	Storage Temperature	-55 to +100	°C	1,2

#### Note:

- Stresses greater than those listed under “Absolute Maximum Ratings” may cause permanent damage to the device. This is a stress rating only and functional operation of the device at these or any other conditions above those indicated in the operational sections of this specification is not implied. Exposure to absolute maximum rating conditions for extended periods may affect reliability.
- Storage Temperature is the case surface temperature on the center/top side of the DRAM. For the measurement conditions, please refer to JESD51-2 standard.
- VDD and VDDQ must be within 300mV of each other at all times; and VREFCA must be not greater than 0.6 x VDDQ, When VDD and VDDQ are less than 500mV; VREFCA may be equal to or less than 300mV.
- VPP must be equal or greater than VDD/VDDQ at all times.
- Overshoot area above 1.5V is specified in DDR4 Device Operation.

### DRAM Component Operating Temperature Range

Symbol	Parameter	Rating	Units	Notes
TOPER	Normal Operating Temperature Range	0 to 85	°C	1,2
	Extended Temperature Range	85 to 95	°C	1,3

#### Notes:

- Operating Temperature TOPER is the case surface temperature on the center / top side of the DRAM. For measurement conditions, please refer to the JEDEC document JESD51-2.
- The Normal Temperature Range specifies the temperatures where all DRAM specifications will be supported. During operation, the DRAM case temperature must be maintained between 0 - 85°C under all operating conditions.
- Some applications require operation of the DRAM in the Extended Temperature Range between 85°C and 95°C case temperature. Full specifications are guaranteed in this range, but the following additional conditions apply:
  - Refresh commands must be doubled in frequency, therefore reducing the Refresh interval tREFI to 3.9 μs. It is also possible to specify a component with 1X refresh (tREFI to 7.8μs) in the Extended Temperature Range. Please refer to the DIMM SPD for option availability.
  - If Self-Refresh operation is required in the Extended Temperature Range, then it is mandatory to either use the Manual Self-Refresh mode with Extended Temperature Range capability (MR2 A6 = 0b and MR2 A7 = 1b) or enable the optional Auto Self-Refresh mode (MR2 A6 = 1b and MR2 A7 = 0b).



## AC & DC Operating Conditions

### Recommended DC Operating Conditions

Symbol	Parameter	Rating			Unit	NOTE
		Min.	Typ.	Max.		
VDD	Supply Voltage	1.14	1.2	1.26	V	1,2,3
VDDQ	Supply Voltage for Output	1.14	1.2	1.26	V	1,2,3
VPP	Supply Voltage for DRAM Activating	2.375	2.5	2.75	V	3

**Notes:**

- Under all conditions VDDQ must be less than or equal to VDD, this voltage refers to the value of the default frequency.
- VDDQ tracks with VDD. AC parameters are measured with VDD and VDDQ tied together.
- DC bandwidth is limited to 20MHz.

## Module With Heat Spreader

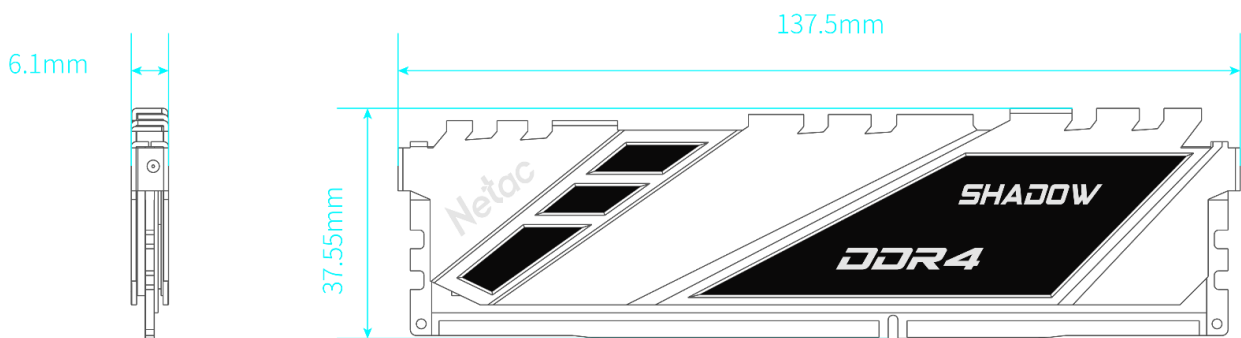

## Module Dimensions

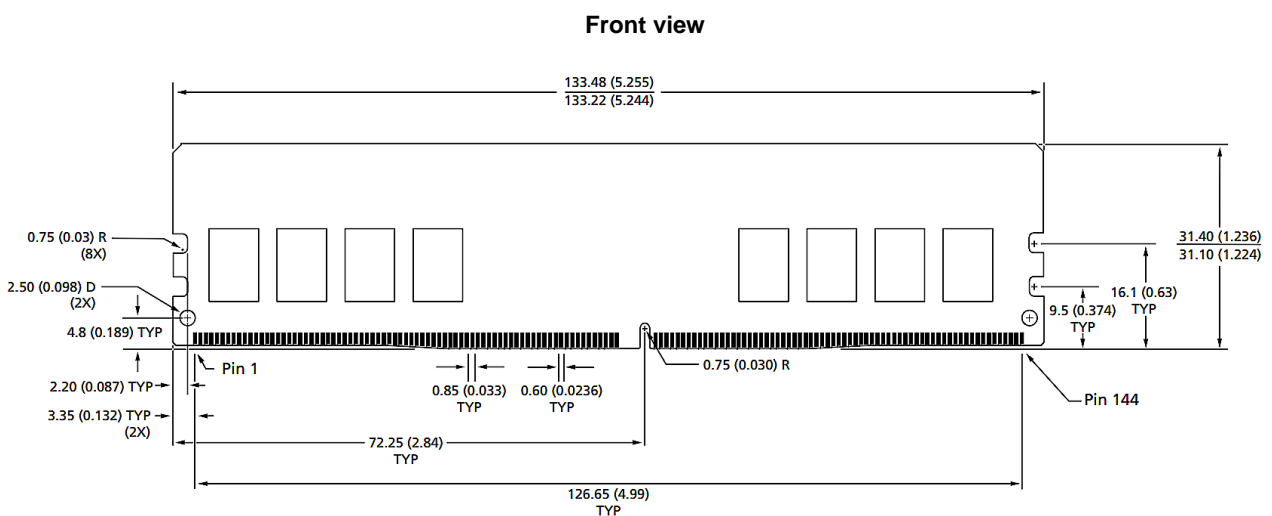

Back view

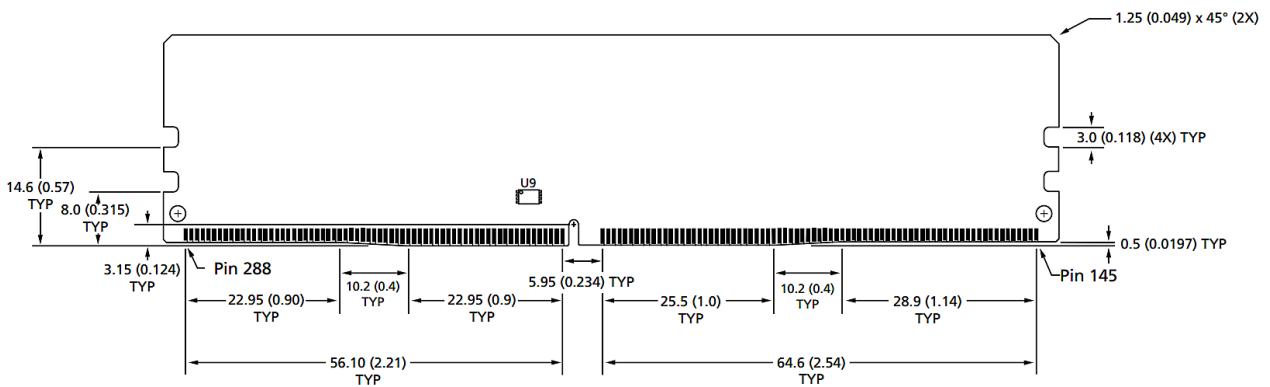

Notes:

1. All dimensions are in millimeters (inches); MAX/MIN or typical (TYP) where noted.
2. Tolerance on all dimensions  $\pm 0.15$ mm unless otherwise specified.
3. The dimensional diagram is for reference only.

Front view

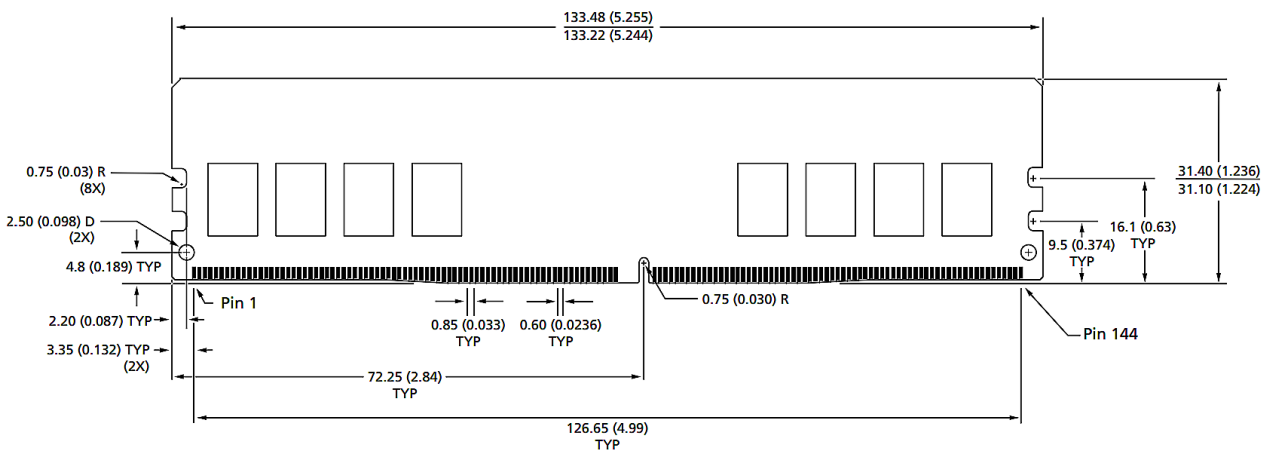

Back view

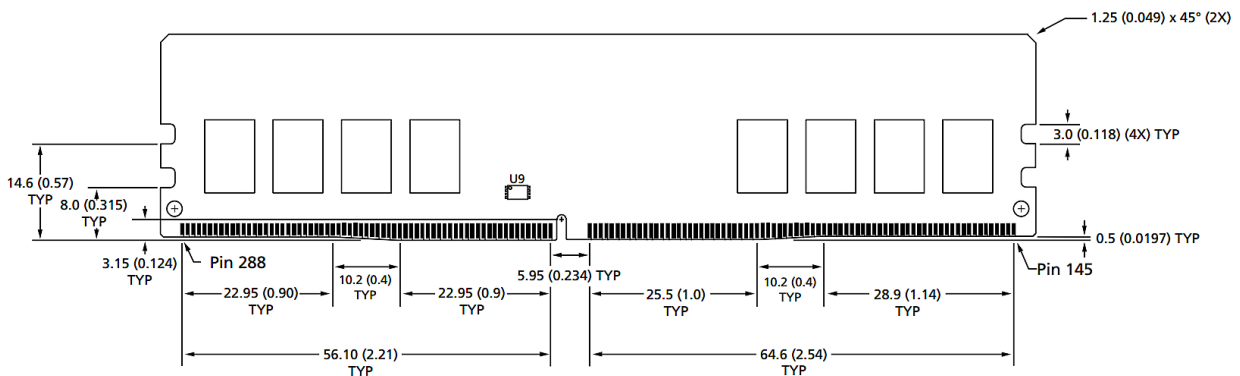

Notes:

1. All dimensions are in millimeters (inches); MAX/MIN or typical (TYP) where noted.
2. Tolerance on all dimensions  $\pm 0.15$ mm unless otherwise specified.
3. The dimensional diagram is for reference only.

Front view

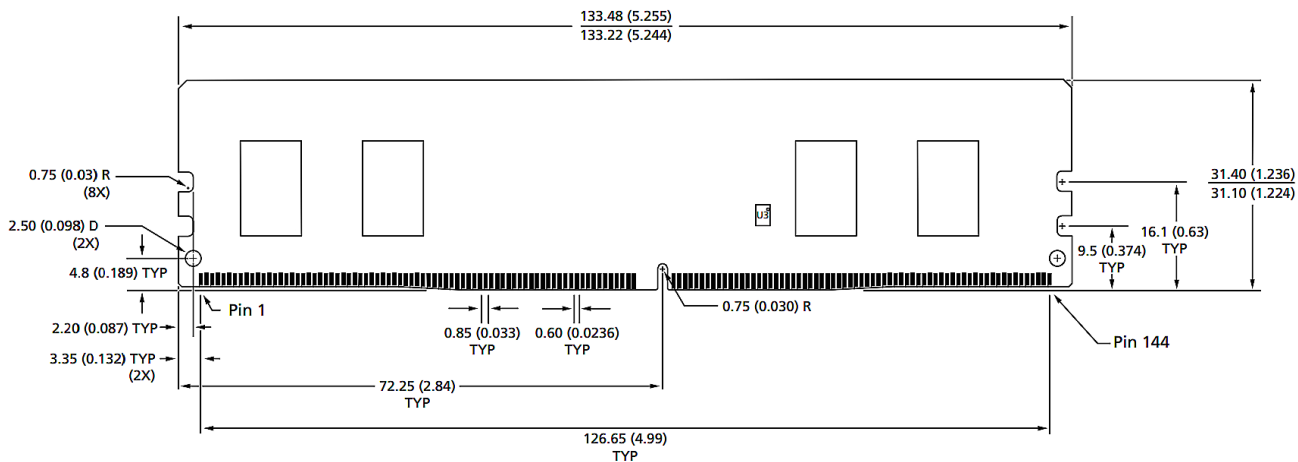

Back view

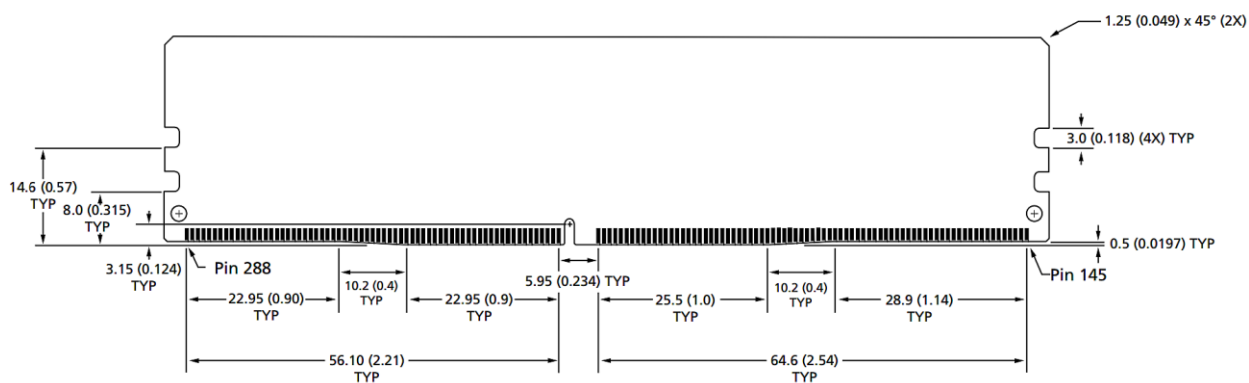

Notes:

1. All dimensions are in millimeters (inches); MAX/MIN or typical (TYP) where noted.
2. Tolerance on all dimensions  $\pm 0.15$ mm unless otherwise specified.
3. The dimensional diagram is for reference only.